

# Molding Type Power Inductor

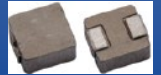

ASPI-0630LR

Request Samples



Check Inventory



7.1 x 6.60 x 2.8 mm  
RoHS/RoHS II Compliant  
MSL Level = 1

## Features

- High saturation current
- Low loss due to low DC resistance
- Frequency application up to 3MHz
- Low profile with max thickness 3.0mm

## Applications

- DC/DC converters in Notebook, desktops and servers
- Low profile, high current power supplies

## Electrical Specifications

Part Number	Inductance	Tolerance	DCR Max	Saturation Current Typ.	Temperature Rise Current Typ.
Units	$\mu$ H	%	m $\Omega$	A	A
Symbol	L	M		Isat	Irms
ASPI-0630LR-R22	0.22	M	3.0	34.0	24.0
ASPI-0630LR-R33	0.33	M	3.5	23.0	21.0
ASPI-0630LR-R47	0.47	M	4.1	20.0	18.0
ASPI-0630LR-R56	0.56	M	5.0	18.0	16.0
ASPI-0630LR-R68	0.68	M	6.5	17.0	16.0
ASPI-0630LR-R82	0.82	M	7.5	16.0	14.0
ASPI-0630LR-1R0	1.0	M	9.0	15.0	12.0
ASPI-0630LR-1R5	1.5	M	12.1	12.0	10.0
ASPI-0630LR-2R2	2.2	M	18.5	10.0	8.0
ASPI-0630LR-3R3	3.3	M	28.0	9.5	6.5
ASPI-0630LR-4R7	4.7	M	35.0	6.5	5.5
ASPI-0630LR-5R6	5.6	M	42.0	5.0	5.0
ASPI-0630LR-6R8	6.8	M	60.0	6.0	4.5
ASPI-0630LR-8R2	8.2	M	60.0	5.5	5.0
ASPI-0630LR-100	10.0	M	68.0	5.5	4.0
ASPI-0630LR-150	15.0	M	120.0	4.0	3.0
ASPI-0630LR-220	22.0	M	170.0	2.5	2.5
ASPI-0630LR-330	33.0	M	270.0	2.5	2.0
ASPI-0630LR-470	47.0	M	385.0	2.0	1.5

## Test Conditions

Inductance is measured using Wayne Kerr3260+3265B at 100KHz, 1V.

RDC is measured using HIOKI3540.

Isat: Based on inductance change ( $\Delta L/L_0 : \leq -30\%$ )

Irms: Based on temperature rise ( $\Delta T : 40^\circ\text{C TYP.}$ )

**Operating Temperature:**  $-55^\circ\text{C}$  to  $+125^\circ\text{C}$  (Including self-generated heat)

**Storage Temperature and Humidity:**  $< 35^\circ\text{C}$ , 35% to 65% RH

# Molding Type Power Inductor



**ASPI-0630LR**

Request Samples



Check Inventory



7.1 x 6.60 x 2.8 mm  
**RoHS/RoHS II Compliant**  
 MSL Level = 1

## Electrical Characteristic Curves

### ASPI-0630LR-1R0

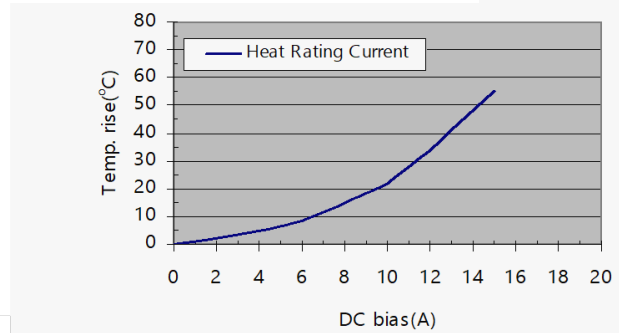
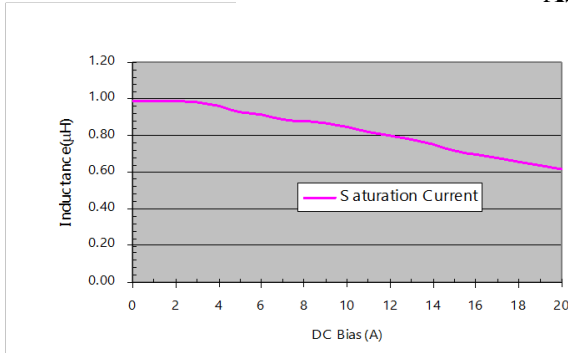

### ASPI-0630LR-1R5

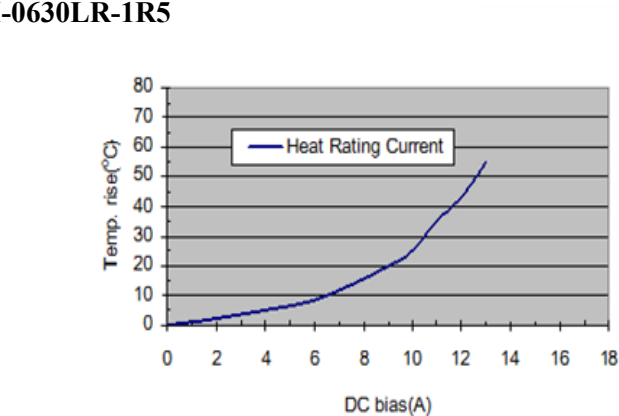
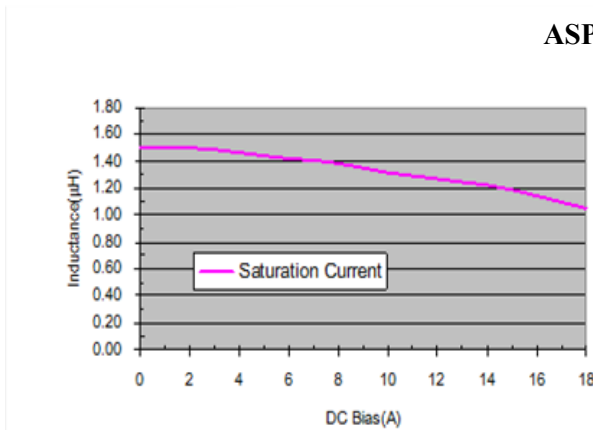

### ASPI-0630LR-2R2

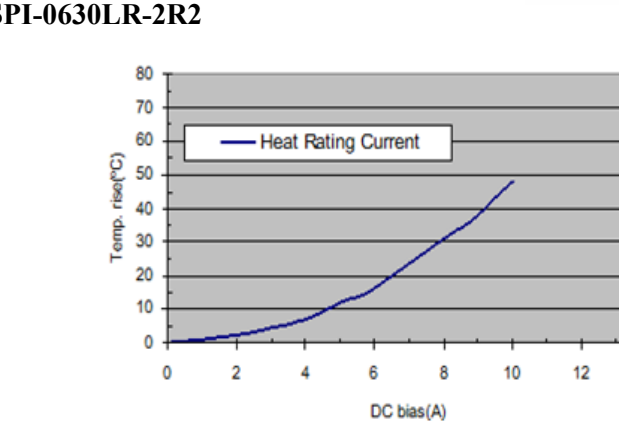
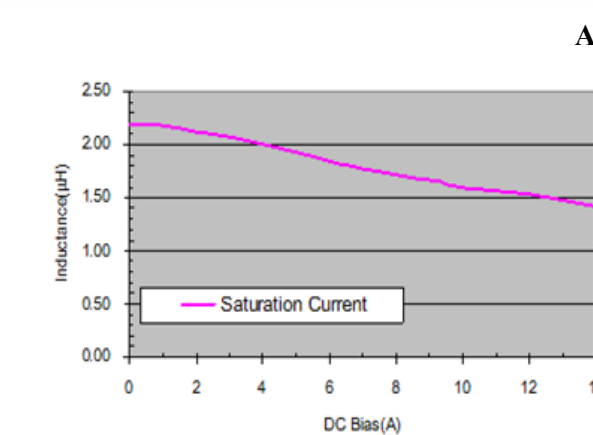

# Molding Type Power Inductor



**ASPI-0630LR**

Request Samples



Check Inventory



7.1 x 6.60 x 2.8 mm  
**RoHS/RoHS II Compliant**  
 MSL Level = 1

## ASPI-0630LR-3R3

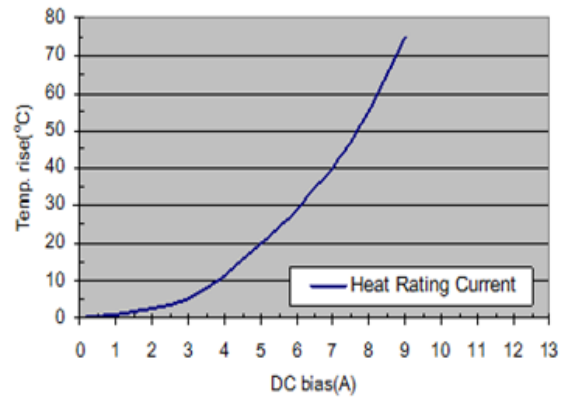
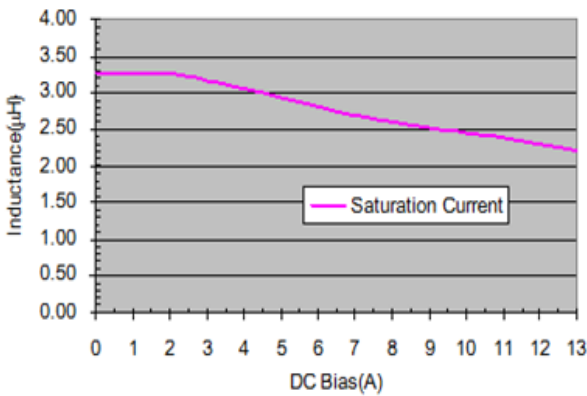

## ASPI-0630LR-4R7

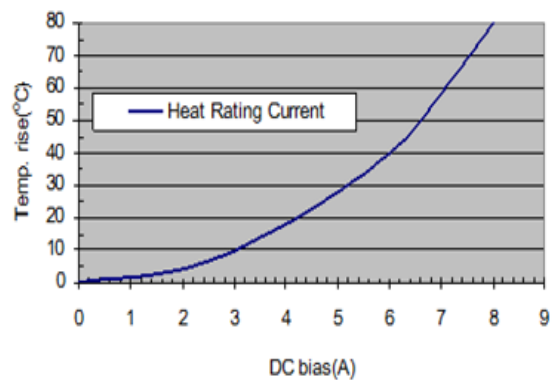
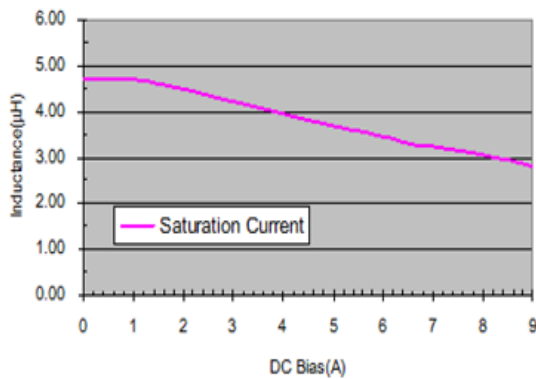

## ASPI-0630LR-5R6

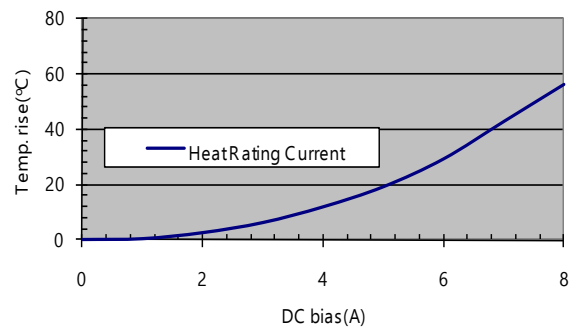
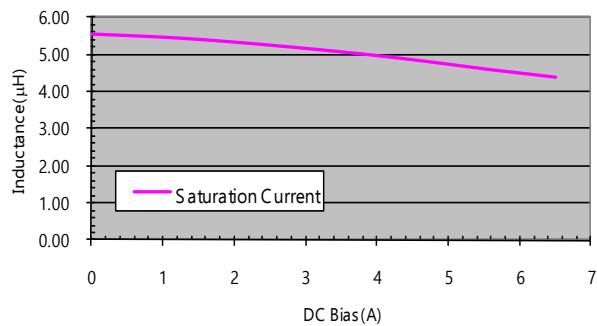

# Molding Type Power Inductor



**ASPI-0630LR**

Request Samples



Check Inventory



7.1 x 6.60 x 2.8 mm  
**RoHS/RoHS II Compliant**  
 MSL Level = 1

## ASPI-0630LR-6R8

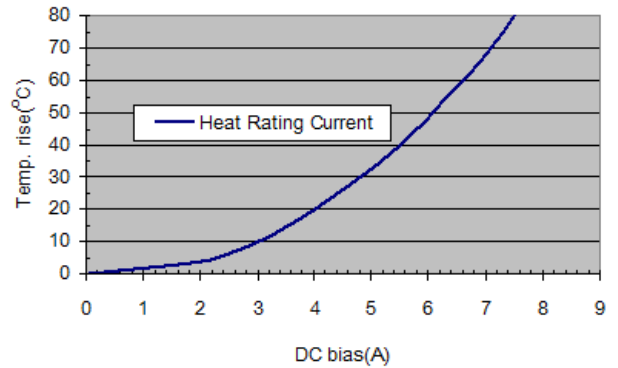
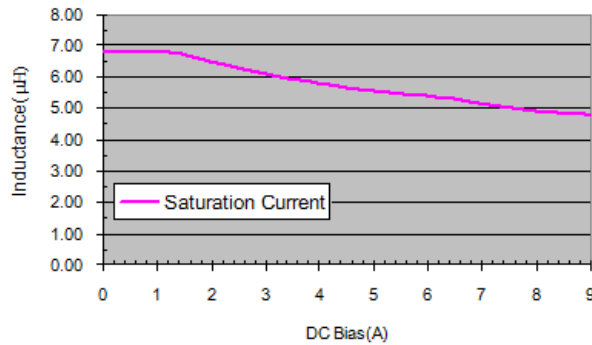

## ASPI-0630LR-100

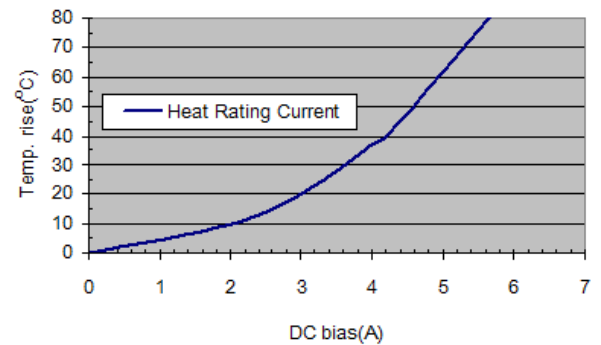
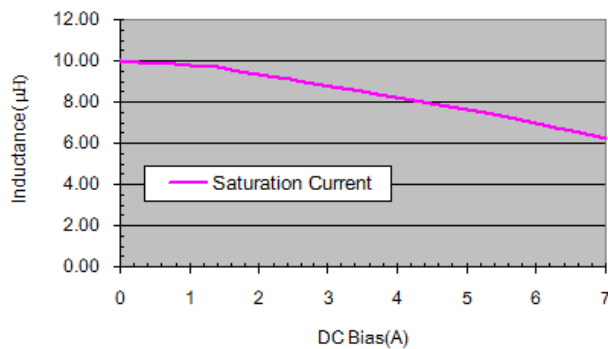

## ASPI-0630LR-150

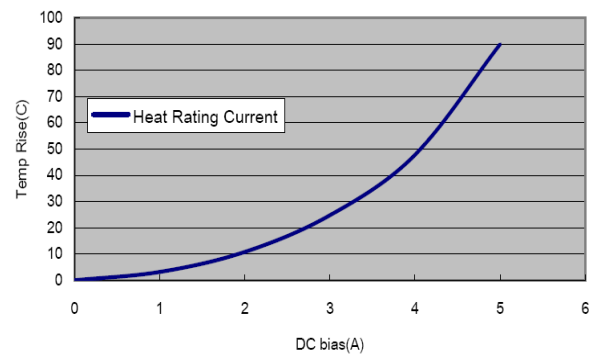
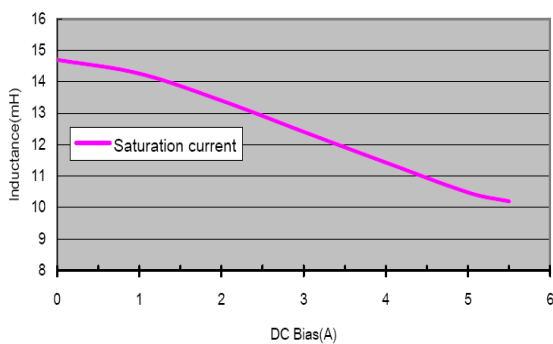

# Molding Type Power Inductor

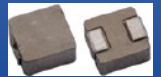

**ASPI-0630LR**

Request Samples



Check Inventory



7.1 x 6.60 x 2.8 mm  
**RoHS/RoHS II Compliant**  
 MSL Level = 1

## ASPI-0630LR-R47

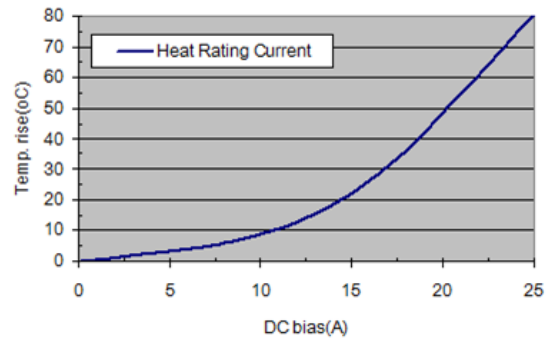
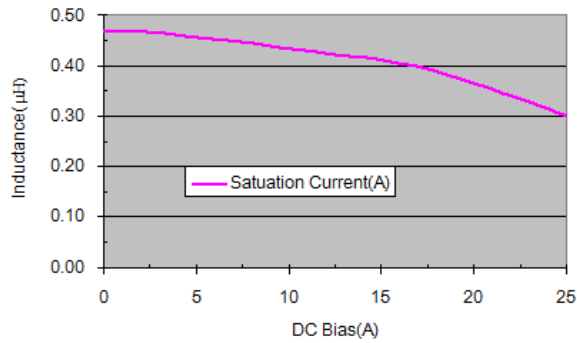

## ASPI-0630LR-R56

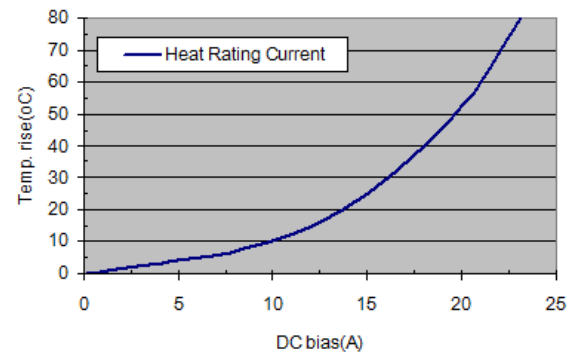
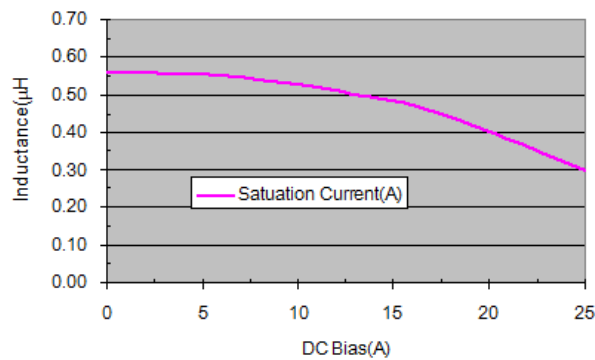

## ASPI-0630LR-R68

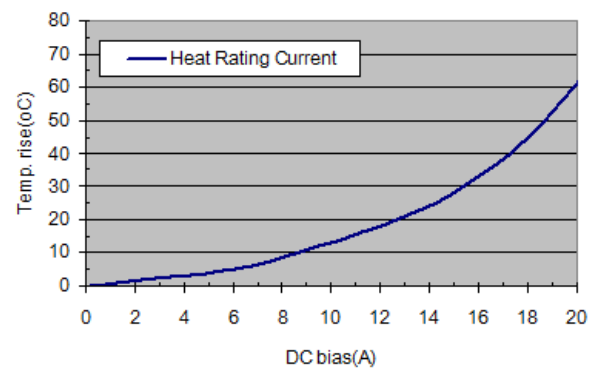
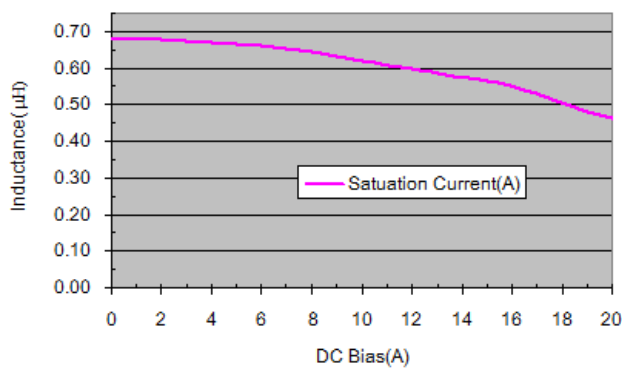

# Molding Type Power Inductor

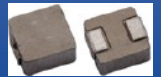

**ASPI-0630LR**

Request Samples



Check Inventory



7.1 x 6.60 x 2.8 mm  
**RoHS/RoHS II Compliant**  
 MSL Level = 1

## ASPI-0630LR-R82

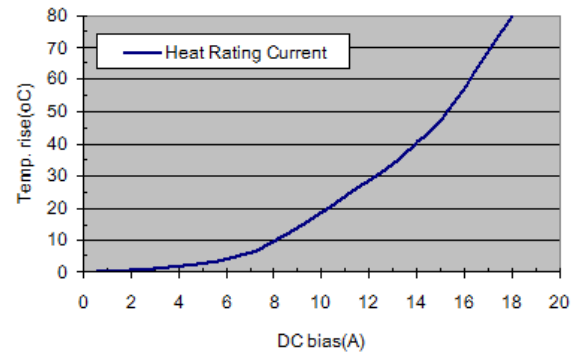
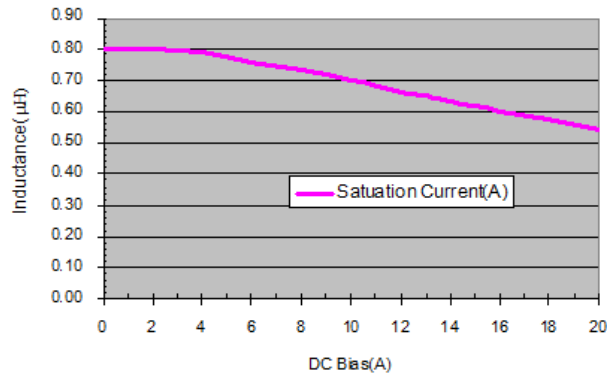

## Part Identification

ASPI-0630LR-  -

**Inductance Code**  
 Please refer to the Electrical Spec Table

**Tolerance**  
 M: ±20%

**Packaging**  
 T15: Tape and Reel  
 (1.5kpcs / reel)

## Materials

No.	Description	Specification
a	Marking	Ink (black)
b	Core	Alloy Sponge Powder
c	Wire	Polyurethane copper wire
d	Terminal	Copper plated with Sn

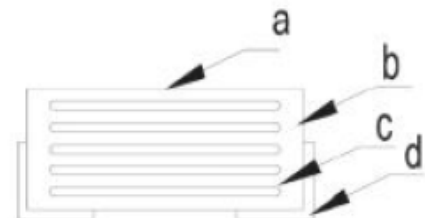

# Molding Type Power Inductor

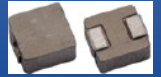

**ASPI-0630LR**

Request Samples



Check Inventory



7.1 x 6.60 x 2.8 mm  
**RoHS/RoHS II Compliant**  
 MSL Level = 1

## Marking

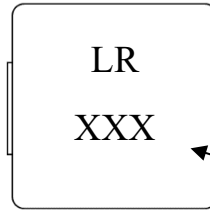

Inductance Code

e.g. 2R2

Marking Method = Ink Marking

## Mechanical Specifications

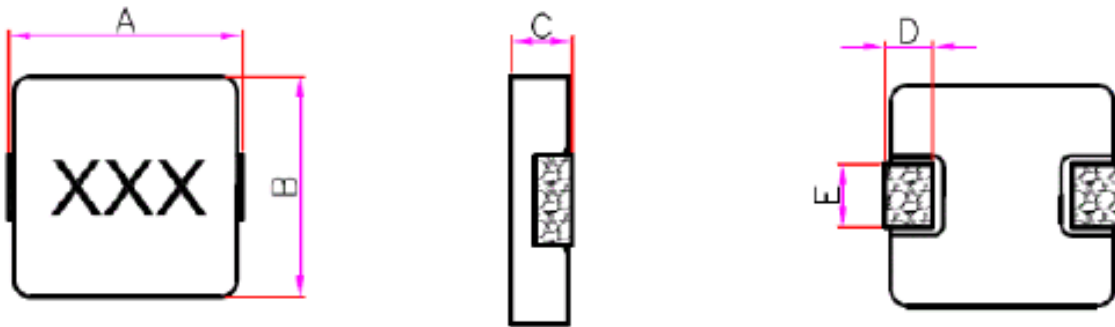

A	B	C	D	E
7.1 ±0.4	6.6 ±0.25	2.8 ±0.2	1.6 ±0.4	3.00 ±0.3

### Recommended Land Pattern

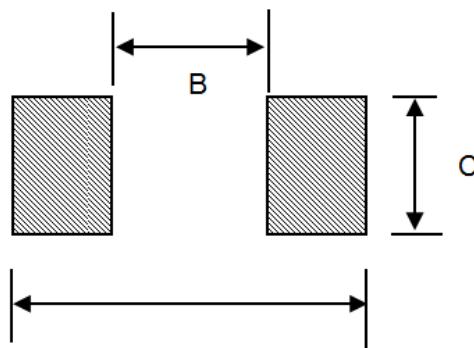

Dimension: mm

A	B	C
8.4	3.7	3.5

# Molding Type Power Inductor

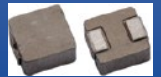

**ASPI-0630LR**

Request Samples



Check Inventory



7.1 x 6.60 x 2.8 mm  
**RoHS/RoHS II Compliant**  
 MSL Level = 1

## Reflow Profile

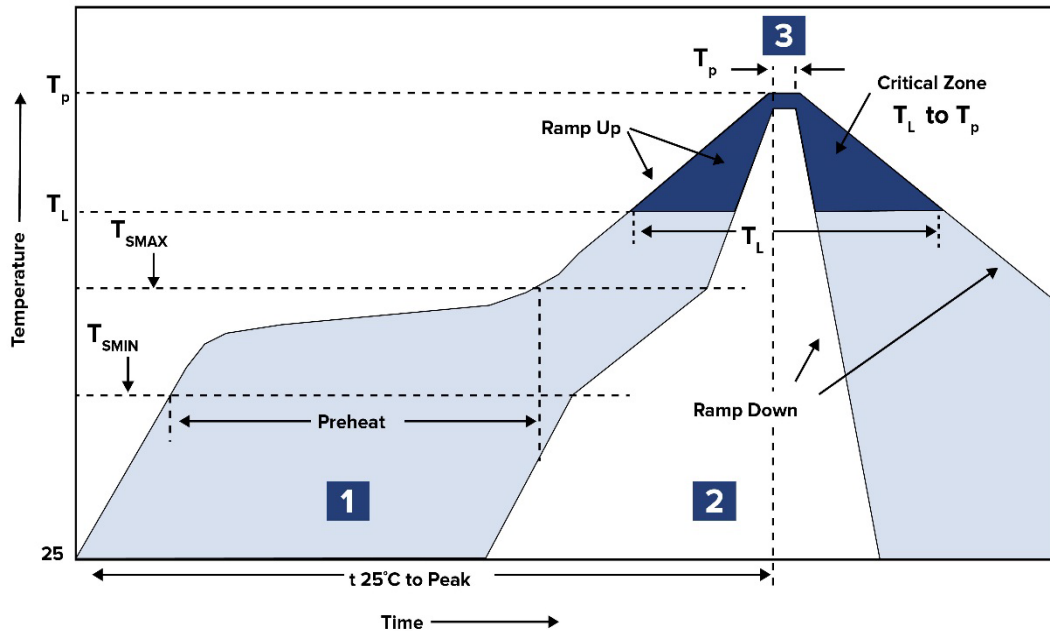

Zone	Description	Temperature	Times
1	Preheat	$T_{SMIN} \sim T_{SMAX}$ 150°C ~ 200°C	60 ~120 Sec.
2	Reflow	$T_L$ 217°C	60 ~90 Sec.
3	Peak heat	$T_P$ 255°C (0/ -5°C)	10 sec. Max



# Molding Type Power Inductor

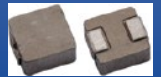

**ASPI-0630LR**

Request Samples



Check Inventory



7.1 x 6.60 x 2.8 mm  
**RoHS/RoHS II Compliant**  
 MSL Level = 1

## Packing

**T15: 1,500pcs / reel**

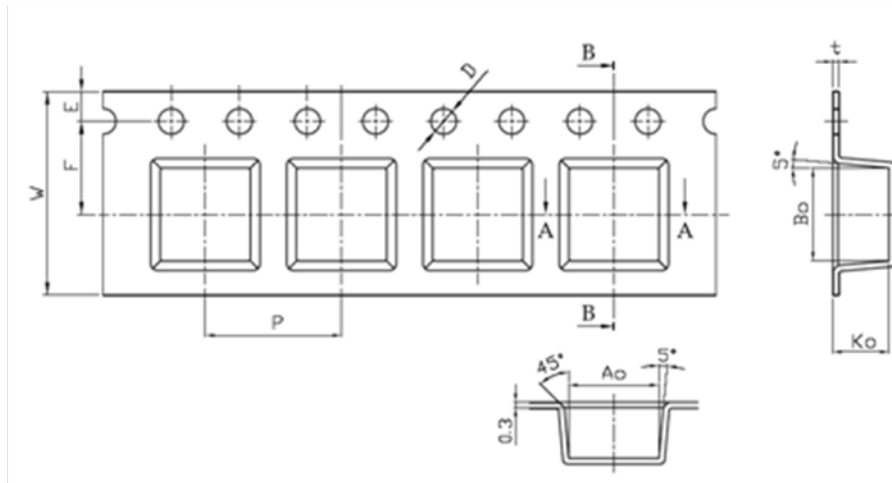

<b>A0</b>	<b>6.9 ±0.3</b>
<b>B0</b>	<b>7.5</b>
<b>K0</b>	<b>3.3 ±0.3</b>
<b>P</b>	<b>12.0</b>
<b>t</b>	<b>0.35 Max</b>
<b>W</b>	<b>16</b>
<b>E</b>	<b>1.75</b>
<b>F</b>	<b>7.5</b>
<b>D</b>	<b>1.5</b>

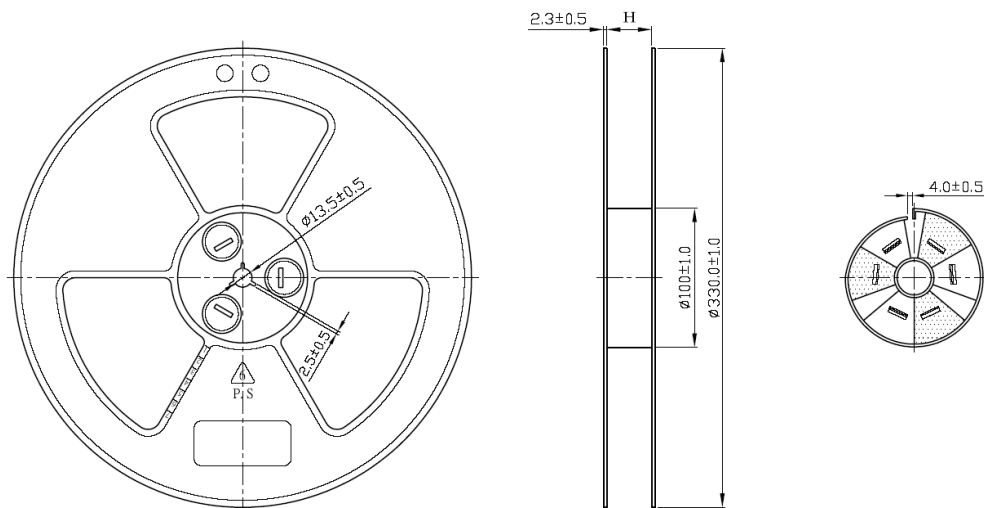

**Dimension: mm**

**ATTENTION:** Abracon LLC's products are COTS – Commercial-Off-The-Shelf products; suitable for Commercial, Industrial and, where designated, Automotive Applications. Abracon's products are not specifically designed for Military, Aviation, Aerospace, Life-dependent Medical applications or any application requiring high reliability where component failure could result in loss of life and/or property. For applications requiring high reliability and/or presenting an extreme operating environment, written consent and authorization from Abracon LLC is required. Please contact Abracon LLC for more information.



5101 Hidden Creek Ln Spicewood TX 78669  
 Phone: 512-371-6159 | Fax: 512-351-8858  
 For terms and conditions of sales, please visit:  
[www.abracon.com](http://www.abracon.com)

**REVISION: B 03-02-22**

ABRACON IS  
 ISO9001-2015  
 CERTIFIED

# Mouser Electronics

Authorized Distributor

Click to View Pricing, Inventory, Delivery & Lifecycle Information:

## ABRACON:

[ASPI-0630LR-100M-T15](#) [ASPI-0630LR-150M-T15](#) [ASPI-0630LR-1R0M-T15](#) [ASPI-0630LR-1R5M-T15](#) [ASPI-0630LR-220M-T15](#) [ASPI-0630LR-2R2M-T15](#) [ASPI-0630LR-3R3M-T15](#) [ASPI-0630LR-4R7M-T15](#) [ASPI-0630LR-5R6M-T15](#) [ASPI-0630LR-6R8M-T15](#) [ASPI-0630LR-R47M-T15](#) [ASPI-0630LR-R56M-T15](#) [ASPI-0630LR-R68M-T15](#) [ASPI-0630LR-R82M-T15](#)